

PCB terminal block — TLM series ( Screwless Type ) — TLM-302R

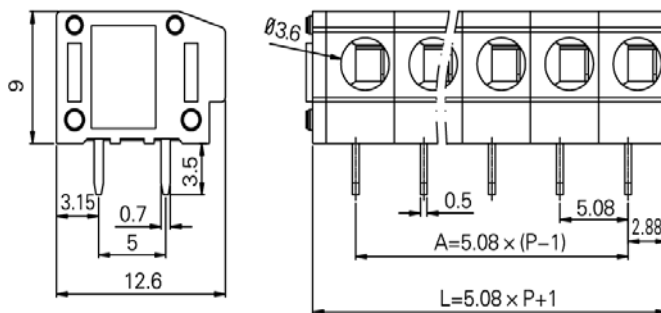

■ 图示(Pic. shown) : TLM-302R-06P-M19

General.	PCB terminal block	Rated : 320V,16A , 1.5mm <sup>2</sup>
	Single row , 5.08mm pitch , 02-24 Pole	
	Wiring orientation: 180°(wire-to-board)	
	Screwless Type	

认证 ( Approval ) :

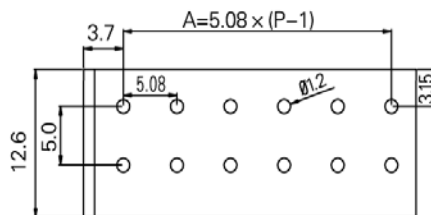
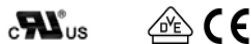

PCB Layout

技术参数 Technical Data	UL standard			IEC standard		
	UL Application group			IEC过电压别/污染等级(IEC overvoltage category /pollution degree)		
UL应用组别(UL Application group)	UL Application group			IEC过电压别/污染等级(IEC overvoltage category /pollution degree)		
IEC过电压别/污染等级(IEC overvoltage category /pollution degree)	B	C	D	III / 3	III / 2	II / 2
额定电压(Rated voltage)	300V	--	300V	--	320V	--
额定电流(Rated current)	10A	--	10A	--	16A	--
额定连接容量(Rated connection capacity)	20-14AWG Sol&Str			0.34~1.5mm <sup>2</sup> Sol&Str,2.5mm <sup>2</sup> Sol Max		
绝缘材料(Insulation Material)				PA66 UL94 V-0		
电流承载部件材料和镀层( Material & Plating of Current carrier )				Copper alloy , Tin plated		
接线弹片材料(Material of Clamp spring )				--		
绝缘电阻(Insulation Resistance)				500MΩ or more at DC500V		
耐电压(1分钟)(Withstanding Voltage/1Min)				1600V		
额定冲击电压(Rated surge voltage)				--		
接线螺丝(Wire clamp unit Screw) , 最大扭矩( torque Max. )				--		
固定螺丝(Mounting Screw) , 扭矩(torque)				--		
剥线长度(Wire stripping length)				9.0mm		
使用温度(Operating temperature)				-40°C up to +105°C		
焊接方式(Soldering recommend)	Wave soldering ,260°C 5S Max (Single Wave) , 260°C 10S Max(Double Wave)					

■ 订购方式(How to order)

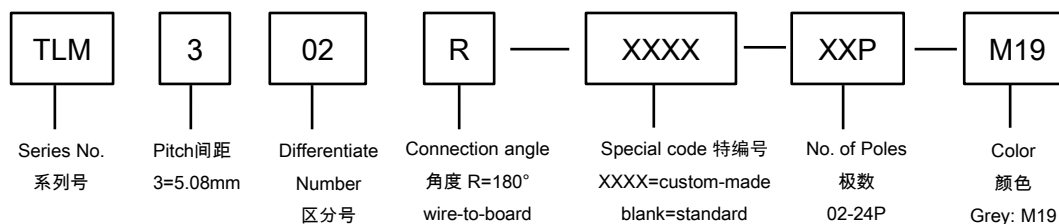

Web:www.china-tianli.com

TEL:+86-574-6347-9600,6389-6436

Mail : sale@china-tianli.cn

地址:中国浙江省宁波杭州湾新区庵东工业园区纬三路138号

ADD : 138 , Weisan Rd.,Andong Development Zone, Hangzhou Bay Area, Ningbo, Zhejiang, China