

PCB terminal block — BARRIER SERIES — B100C-03-0852

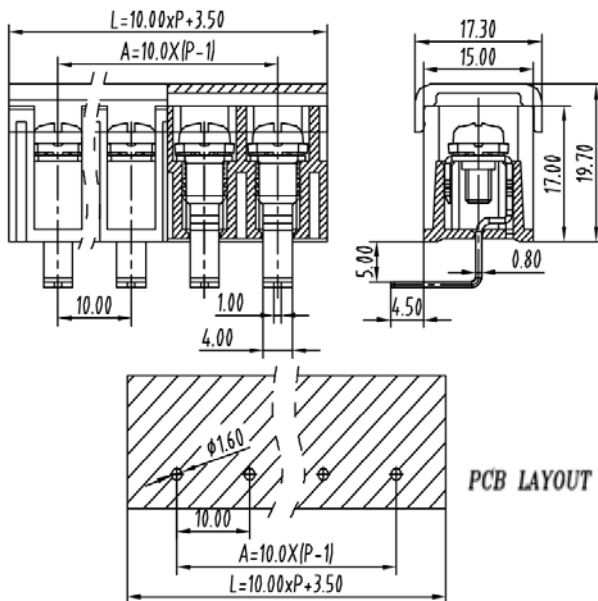

■ 图示(Pic. shown) : B100C-03-0852-09P-KC

General:
 PCB terminal block Rated : 300V,25A , 22-10 Sol&Str
 Single row , 10.0mm pitch , 02-30 Pole
 Wiring orientation: 180°(wire-to-board)
 Screw clamp unit: M3.5, 1.0Nm Max

认证 (Approval) :

■ 技术参数 Technical Data	UL standard			IEC standard		
	UL Application group			IEC过电压别/污染等级(IEC overvoltage category /pollution degree)		
UL应用组别(UL Application group)	UL Application group			IEC过电压别/污染等级(IEC overvoltage category /pollution degree)		
IEC过电压别/污染等级(IEC overvoltage category /pollution degree)	B	C	D	III / 3	III / 2	II / 2
额定电压(Rated voltage)	300V	--	300V	--	--	--
额定电流(Rated current)	25A	--	10A	--	--	--
额定连接容量(Rated connection capacity)	22-10AWG Sol&Str			--		
绝缘材料(Insulation Material)				PBT		
电流承载部件材料和镀层(Material & Plating of Current carrier)				Copper alloy , Tin plated		
接线弹片材料(Material of Clamp spring)				--		
绝缘电阻(Insulation Resistance)				500MΩ or more at DC500V		
耐电压(1分钟)(Withstanding Voltage/1Min)				2000V		
额定冲击电压(Rated surge voltage)				--		
接线螺丝(Wire clamp unit Screw) , 最大扭矩(torque Max.)				M3.5 , 1.0Nm Max		
固定螺丝(Mounting Screw) , 扭矩(torque)				--		
剥线长度(Wire stripping length)				--		
使用温度(Operating temperature)				-40°C up to +105°C		
焊接方式(Soldering recommend)	Wave soldering ,260°C 5S Max (Single Wave) , 260°C 10S Max(Double Wave)					

■ 订购方式(How to order)

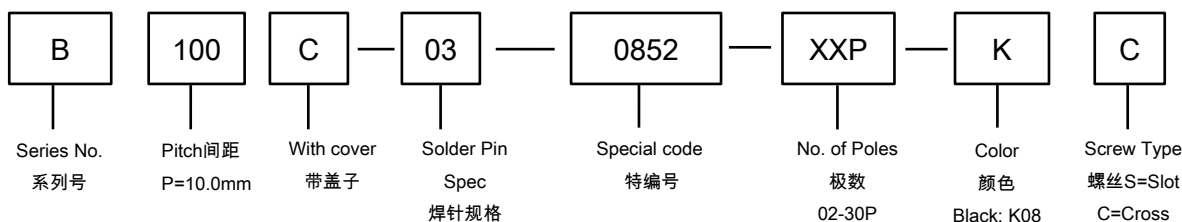

Web:www.china-tianli.com TEL:+86-574-6347-9600,6389-6436 Mail : sale@china-tianli.cn
 地址:中国浙江省宁波杭州湾新区庵东工业园区纬三路138号
 ADD : 138 , Weisan Rd.,Andong Development Zone, Hangzhou Bay Area, Ningbo, Zhejiang, China